

**LABOR CABINET**  
**Department of Workplace Standards**  
**Division of Occupational Safety and Health Compliance**  
**Division of Occupational Safety and Health Education and Training**  
**(Amendment)**

**803 KAR 2:325. General industry standards.**

RELATES TO: KRS Chapter 338

STATUTORY AUTHORITY: KRS 338.051(3), 338.061 [~~KRS Chapter 13A~~]

NECESSITY, FUNCTION, AND CONFORMITY: KRS 338.051(3) requires [and 338.061 authorize] the Kentucky Occupational Safety and Health Standards Board to [adopt and] promulgate occupational safety and health [rules, administrative] regulations [and standards] and authorizes the chairman to reference federal standards without board approval if necessary to meet federal time requirements. KRS 338.061 authorizes the board to establish, modify, or repeal standards and reference federal standards. This administrative regulation establishes standards that are enforced by the Department of Workplace Standards in general industry [Consistent with this authority the following administrative regulations contain those standards to be enforced by the Division of Occupational Safety and Health Compliance. The Occupational Safety and Health Standards Board hereby adopts the following administrative regulations applicable to general industry. Necessary for effective enforcement of the purposes and policies of the Occupational Safety and Health Act which is to insure so far as is possible, safe and healthful working conditions of Kentucky workers (KRS 338.011)].

Section 1. Definitions. (1) "C.F.R." means Code of Federal Regulations.

(2) "Employee" is defined by KRS 339.015(2).

(3) "Employer" is defined by KRS 338.015(1).

Section 2. Batteries. Changing and charging storage batteries [(for automotive-type battery charging installations, in-vehicle charging of batteries, and battery jump starting of vehicles)].

(1)(a) Facilities shall be provided for flushing electrolyte from the eyes and skin with water when changing or charging storage batteries.

(b) An adequate water supply shall be within twenty-five (25) feet of the work area.

(2)(a) No battery shall be charged or discharged within a closed or unvented container.

(b) The batteries shall be charged:

1. [(a)] In the open; or

2. [(b)] In a mechanically-ventilated space; or

3. [(c)] In a space providing at least twenty (20) cubic feet per ampere of charging capacity.

(3)(a) A face shield or goggles shall be provided and available at each charging unit.

(b) The use of the face shield or goggles shall be required for connection and disconnection of vehicle or charger leads to the battery terminals and for the addition or pouring of electrolyte.

(4) Employees shall wear face shields or goggles during installation and removal of batteries from vehicles, while connecting and disconnecting battery charger or jumper cable leads, or [~~and~~] while handling electrolyte.

(5) Employees shall be instructed to:

(a) Turn off the battery charger to connect or disconnect the battery;

(b) Wash acid spills immediately; and

(c) Flush electrolyte from eyes and skin with water for ten (10) minutes.

Section 3 [2]. [Safety and Testing of Supply Lines in Excess of 600 Volts. (1) Definitions.

(a) ~~Disconnected means disconnected from any electrical source of supply;~~

(b) ~~Guarded: protected by personnel, covered, fenced, or enclosed by means of suitable castings, barrier, rails, screens, mats, platforms, or other suitable devices in accordance with standard barricading techniques designed to prevent dangerous approach or contact by persons or objects. (Note: Wires, which are insulated but not otherwise protected, are not considered as guarded);~~

(c) ~~Hold cards (also called "hold tags"): a card or tag type device, usually having a predominant color of white or red which warns against or which cautions against the operation of a particular switch, device, circuit, tool, machine, etc.;~~

(d) ~~Near: a distance no closer than that shown in the table in subsection (3)(c) of this section;~~

(e) ~~Qualified person: a person who, because of experience and training is familiar with the construction and operation of the apparatus or equipment and the hazards involved in the performance of the job.~~

~~(2) Purpose.~~

(a) ~~The intent and purpose of this administrative regulation is to provide and establish safety procedures for testing equipment to protect electrical workers from hazards resulting from exposure to high voltage;~~

(b) ~~This administrative regulation shall apply to nonutility electrical workers who are engaged in electrical construction or maintenance of electrical conductors and equipment rated at 600 volts and above.~~

~~(3) Energized conductors and equipment.~~

(a) ~~Only qualified employees shall work on or near high voltage conductors or equipment;~~

(b) ~~Personal protective equipment shall be provided by the employer and used by the employee when working on or near energized, ungrounded high voltage conductors or equipment;~~

~~(c) No employee shall approach or take any conductive object, without an approved insulating handle, within the minimum distance specified in the table below, unless the energized part is insulated or guarded from the employee, or the employee is effectively insulated from the live parts. Rubber gloves (sleeves if necessary) rated for the voltage involved shall be considered effective insulation of the employee from the energized part.~~

Minimum Clear Distance From Live Parts	
Voltage Phase to Phase (Kilovolts)	Distance Phase to Employee
0.6 to 34.5	2'
34.5 to 46	2 1/2'
46 to 69	3'
69 to 115	3' 4"
115 to 138	3' 6"
138 to 169	3' 8"

~~(4) Deenergized conductor or equipment.~~

(a) ~~Existing conditions shall be determined before starting work on electrical conductor and/or equipment;~~

(b) ~~Before any work is performed, all electrical switches, breakers and associated disconnecting devices shall be opened, made inoperable and hold tagged out by the person in charge. Employees shall be trained and thoroughly instructed in the tagging procedure. One (1) qualified person, for example: foreman, general foreman or first class electrician, of each crew shall be responsible for attaching hold tags and/or hold cards to the disconnecting means. When more than one (1) crew is involved in the work, multiple hold tags or hold cards shall be placed in the handle of the disconnecting equipment. The use of such tags must be respected. Equipment or items so tagged must not be activated or used without full and proper authority of a responsible person whose signature appears on the tag;~~

- ~~(c) Conductors shall be short circuited and grounded wherever possible;~~
- ~~(d) Capacitors may be components of apparatus of the disconnected electrical system. Before employees are allowed to work, the capacitors shall be discharged, short circuited and grounded;~~
- ~~(e) When deenergizing conductors and equipment and the means of disconnecting from the energy source is not visibly open, a voltage test shall be made before starting work. An operational check shall be made of the voltage tester prior to and following the voltage test to determine reliability of the testing device. The test device must be handled and used while wearing or using approved protective equipment during the test;~~
- ~~(f) All conductors and equipment shall be treated as energized until tested, short circuited and effectively grounded except when the circuit involved is isolated from all possible sources of energizing voltage from another circuit, induced voltage or back feed;~~
- ~~(g) The voltage condition of deenergized conductors and/or equipment shall be determined with testing equipment designed for the applicable voltage;~~
- ~~(h) Upon completion of work on deenergized conductors and equipment, the person responsible shall ascertain that all employees under his jurisdiction are clear and that all protective short circuit and grounding lines are removed. The qualified person(s) shall then remove his hold tag(s). Only at this time shall conductors and equipment be reenergized.~~

~~Section 3. Safety Belts, Lanyards and Life Lines. (1) Employees working from open-sided unguarded floors, pipe racks, and ledges, platforms, walkways, machinery, stock shelves, or similar unguarded working surfaces which are elevated ten (10) feet or more above a lower level shall be secured by safety belts and lanyards, life lines where necessary, or shall be protected by safety nets.~~

~~(2) Lanyards shall have a nominal breaking strength of 5,400 lbs. The combination of safety belts and lanyards, life lines where necessary, shall be designed to permit a fall of not more than five (5) feet.~~

~~(3) All safety belt and lanyard hardware, except rivets, shall be capable of withstanding a tensile loading of 4,000 lbs. without cracking, breaking or taking a permanent deformation.~~

~~(4) Life lines, where necessary, shall be secured above the point of operation to an anchorage of structural member capable of supporting a minimum dead weight of 5,400 lbs.~~

~~(5) This standard shall not preempt any applicable standard now in effect.~~

~~Section 4.] Off-highway Motor Vehicles and Equipment. (1) General requirements.~~

~~(a) Heavy machinery, equipment, or parts [thereof, which are] suspended or held aloft by use of slings, hoists, or jacks shall be substantially blocked or cribbed to prevent falling or shifting before employees are permitted to work under or between them.~~

~~(b) 1. Bulldozers and scraper blades, end-loader buckets, dump bodies, and similar equipment, shall be either fully lowered or blocked when being repaired or when not in use.~~

~~2. All controls shall be in a neutral position, with the motors stopped and brakes set, unless work being performed requires otherwise.~~

~~(c) [(b)] Whenever the equipment is parked, the parking brake shall be set.~~

~~(d) Equipment parked on inclines shall have the wheels chocked and the parking brake set.~~

~~(e) [(e)] All cab glass shall be safety glass, or equivalent, that introduces no visible distortion affecting the safe operation of any machine covered by this section [subpart].~~

~~(f) [(f)] All equipment covered by this section [subpart] shall comply with the requirements of 29 C.F.R. 1910.333 [1910.180(j)(4)] when working or being moved in the vicinity of power lines or energized transmitters.~~

~~(2) Motor vehicles.~~

(a) Coverage. Motor vehicles ~~[as]~~ covered by this section ~~[part]~~ are those vehicles that operate within an off-highway job site not open to public traffic. The requirements of this section do not apply to equipment ~~[for which rules are prescribed]~~ in subsection (3) of this section.

(b) General requirements.

1. All vehicles shall have a service brake system, an emergency brake system, and a parking brake system.

2. These systems may use common components, and shall be maintained in operable condition.

(c) Whenever visibility conditions warrant additional light, all vehicles, or combinations of vehicles, in use shall be equipped with at least two (2) headlights and two (2) taillights in operable condition.

(d) All vehicles, or combination of vehicles, shall have brake lights in operable condition regardless of light conditions.

(e) All vehicles shall be equipped with an adequate audible warning device at the operator's station and in an operable condition.

(f) Motor vehicle equipment ~~[No employer]~~ shall not be used ~~[use any motor vehicle equipment]~~ having an obstructed view to the rear unless:

1. The vehicle has a reverse signal alarm audible above the surrounding noise level; or

2. The vehicle is backed ~~[up]~~ only when an observer signals that it is safe to do so.

(g)1. All vehicles with cabs shall be equipped with windshields and powered wipers.

2. Cracked and broken glass shall be replaced.

3. Vehicles operating in areas or under conditions that cause fogging or frosting of the windshields shall be equipped with operable defogging or defrosting devices.

(h) All haulage vehicles ~~[, whose pay load is]~~ loaded by means of cranes, power shovels, loaders, or similar equipment, shall have a cab shield or ~~[and/or]~~ canopy adequate to protect the operator from shifting or falling materials.

(i) Tools and material shall be secured to prevent movement when transported in the same compartment with employees.

(j) Vehicles used to transport employees shall have seats firmly secured and adequate for the number of employees ~~[to be]~~ carried.

(k) The employer shall ~~[will]~~ provide and insure the use of seat belts and anchorages meeting the requirements of 49 C.F.R. Part 571, ~~[Department of Transportation, Federal Motor Vehicle Safety Standards]~~.

(l) Trucks with dump bodies shall be equipped with positive means of support, permanently attached, and capable of being locked in position to prevent accidental lowering of the body while maintenance or inspection work is being done.

(m) Operating levers controlling hoisting or dumping devices on haulage bodies shall be equipped with a latch or other device that prevents ~~[which will prevent]~~ accidental starting or tripping of the mechanism.

(n) Trip handles for tailgates of dump trucks shall be so arranged that, in dumping, the operator will be in the clear.

(o)1. Each employer shall assure ~~[that]~~ the following parts, equipment, and accessories are in safe operating condition and free of apparent damage that could cause failure while in use:

a. Service ~~[service]~~ brakes, including trailer brake connections;

b. Parking ~~[parking]~~ system brake ~~[(hand brake)]~~;

c. Brakes ~~[emergency stopping system (brakes)]~~;

d. Tires ~~[tires]~~;

e. Horn ~~[horn]~~;

f. Steering ~~[steering]~~ mechanism;

- g. Coupling [~~coupling~~] devices;
- h. Seat [~~seat~~] belts;
- i. Operating [~~operating~~] controls; and
- j. Safety [~~safety~~] devices.

2. All defects shall be corrected before the vehicle is placed in service.

3. These requirements also apply to equipment such as lights, reflectors, windshield wipers, defrosters, and fire extinguishers[, etc., where such equipment is necessary].

(3) Material handling equipment.

(a) General [~~Equipment; general~~]. The requirements of this subsection [These rules] apply to [~~the following types of equipment:~~] scrapers, loaders, crawler or wheel tractors, bulldozers, off-highway trucks, graders, agricultural and industrial tractors, and similar equipment[. ~~The promulgation of specific rules for compactors and rubber-tired "skid-steer" equipment is reserved pending consideration of standards currently being developed.~~].

(b) Seating and seat belts.

1. Each employer shall insure safe seating with seat belts on all equipment covered by this section, and shall meet the requirement of J386, Society of Automotive Engineers Handbook, 1986, Seat Belts for Construction Equipment.

2. Seat belts for agricultural and light industrial tractors shall meet the seat belt requirements of Society of Automotive Engineers J1194, Society of Automotive Engineers Handbook, 1986, Operator Protection for Agricultural and Light Industrial Tractors.

(c) Seat belts need not be provided for equipment [~~which is~~] designed only for stand-up operation.

(d) Seat belts need not be provided for equipment that [~~which~~] does not have rollover protective structure [~~(ROPS)~~] or adequate canopy protection.

(e) Brakes.

1. All equipment mentioned in subsection (a) of this section shall have a service braking system capable of stopping and holding the equipment fully loaded, as specified in Society of Automotive Engineers SAE J237, Loader Dozer, Society of Automotive Engineers Handbook, 1986, J236, Graders, Society of Automotive Engineers Handbook, 1986, and J319b, Scrapers, Society of Automotive Engineers Handbook, 1986.

2. Brake systems for self-propelled rubber-tired off-highway equipment manufactured after January 1, 1987 shall meet the applicable minimum performance criteria set forth in the following Society of Automotive Engineers Recommended Practices. [;]

Self-propelled Scrapers	SAE J319B, Society of Automotive Engineers Handbook, 1986.
Self-propelled Graders	SAE J236, Society of Automotive Engineers Handbook, 1986.
Trucks and Wagons	SAE J166, Society of Automotive Engineers Handbook, 1986.
Front-end Loaders and Dozers	SAE J237, Society of Automotive Engineers Handbook, 1986.

(f) [~~Rollover protective structures for off-highway trucks. The promulgation of standards for rollover protective structures for off-highway trucks is reserved pending further study and development.~~]

(g) Audible alarms.

1.a. All bidirectional machines, such as rollers, compactors, front-end loaders, bulldozers, and similar equipment, shall be equipped with a horn, distinguishable from the surrounding noise level, which shall be operated as needed when the machine is moving in either direction.

b. The horn shall be maintained in an operative condition.

2. ~~Material~~ [No employer shall permit material] handling equipment or compacting equipment ~~that~~ [which] has an obstructed view to the rear shall not to be used in reverse gear unless the equipment has in operation a reverse signal alarm distinguishable from the surrounding noise level or an employee signals that it is safe to do so.

(g) [(h)] Scissor points. Scissor points on all front-end loaders[,] which constitute a hazard to the operator during normal operation[,] shall be guarded.

~~Section 4 [5]. Rollover Protective Structures; Overhead Protection. (1) Rollover protective structure (ROPS) for material handling equipment.~~

~~(a) Coverage. This section applies to the following types of material handling equipment: To all rubber tired, self-propelled scrapers, rubber tired front-end loaders, rubber tired dozers, wheel-type agricultural and industrial tractors, crawler tractors, crawler-type loaders, and motor graders, with or without attachments, that are used in general industry work. This requirement does not apply to sideboom pipe-laying tractors.~~

~~(b) The promulgation of specific standards for rollover protective structures for compactors and rubber tired skid-steer equipment is reserved pending consideration of standards currently being developed.~~

~~(c) Equipment manufactured on or after January 1, 1987. Material handling machinery described in paragraph (a) of this subsection and manufactured on or after January 1, 1987, shall be equipped with rollover protective structures which meet the minimum performance standards prescribed in subsections (2) and (3) of this section as applicable.~~

~~(d) Equipment manufactured before January 1, 1987. All material handling equipment described in paragraph (a) of this subsection and manufactured or placed in service (owned or operated by the employer) prior to January 1, 1987, shall be fitted with rollover protective structures no later than January 1, 1988. Machines manufactured before July 1, 1969: Reserved pending further study, development, and review.~~

~~(e) Rollover protective structures and supporting attachment shall meet the minimum performance criteria detailed in subsections (2) and (3) of this section, as applicable or shall be designed, fabricated, and installed in a manner which will support, based on the ultimate strength of the metal, at least two (2) times the weight of the prime mover applied at the point of impact.~~

~~(f) The design objective shall be to minimize the likelihood of a complete overturn and thereby minimize the possibility of the operator being crushed as a result of a rollover or upset.~~

~~(g) The design shall provide a vertical clearance of at least fifty-two (52) inches from the work deck to the ROPS at the point of ingress or egress.~~

~~(h) Remounting. ROPS removed for any reason, shall be remounted with equal quality, or better, bolts or welding as required for the original mounting.~~

~~(i) Labeling. Each ROPS shall have the following information permanently affixed to the structure:~~

~~1. Manufacturer or fabricator's name and address;~~

~~2. ROPS model number, if any;~~

~~3. Machine make, model, or series number that the structure is designed to fit.~~

~~(j) Machines meeting certain existing governmental requirements. Any machine in use, equipped with rollover protective structures, shall be deemed in compliance with this subsection if it meets the rollover protective structure requirements of the state of California, the U.S.~~

Army Corps of Engineers, or the Bureau of Reclamation of the U.S. Department of the Interior in effect on April 5, 1972. The requirements in effect are:

1. State of California: Construction Safety Orders, issued by the Department of Industrial Relations pursuant to Division 5, Labor Code, sec. 6312, state of California.
2. U.S. Army Corps of Engineers: General Safety Requirements, EM-385-1-1 (March 1967).
3. Bureau of Reclamation, U.S. Department of the Interior: Safety and Health Regulations for Construction. Part II (September 1971).

(2) Minimum performance criteria for rollover protective structures for designated scrapers, loaders, dozers, graders, and crawler tractors.

(a) General. This section prescribes minimum performance criteria for rollover protective structures (ROPS) for rubber-tired self-propelled scrapers; rubber-tired front-end loaders and rubber-tired dozers; crawler tractors, crawler-type loaders, and motor graders. The vehicle and ROPS as a system shall have the structural characteristics prescribed in paragraph (f) of this subsection for each type of machine described in this paragraph.

(b) The static laboratory test prescribed herein will determine the adequacy of the structures used to protect the operator under the following conditions:

1. For rubber-tired self-propelled scrapers, rubber-tired front-end loaders, and rubber-tired dozers: operating between zero and ten (10) miles per hour over hard clay where rollover would be limited to a maximum roll angle of 360 degrees down a slope of thirty (30) degrees maximum.

2. For motor graders: operating between zero and ten (10) miles per hour over hard clay where rollover would be limited to 360 degrees down a slope of thirty (30) degrees maximum.

3. For crawler tractors and crawler-type loaders: operating between zero and ten (10) miles per hour over hard clay where rollover would be limited to a maximum roll angle of 360 degrees down a slope of forty-five (45) degrees.

(c) Facilities and apparatus.

1. The following material is necessary:

a. Material, equipment, and tie-down means adequate to insure that the ROPS and its vehicle frame absorb the applied energy.

b. Equipment necessary to measure and apply loads to the ROPS. Adequate means to measure deflections and lengths should also be provided.

c. Recommended, but not mandatory, types of test setups are illustrated in Figure W-1 for all types of equipment to which this section applies; and in Figure W-2 for rubber-tired self-propelled scrapers; Figure W-3 for rubber-tired front-end loaders, rubber-tired dozers, and motor graders; and Figure W-4 for crawler tractors and crawler-type loaders.

2. Table W-1 contains a listing of the required apparatus for all types of equipment described in paragraph (a) of this subsection.

TABLE W-1	
Means to Measure	Accuracy
Deflection of ROPS, inches	+5% of deflection measured.
Vehicle weight, pounds	+5% of the weight measured.
Force applied to frame pounds	+5% of force measured.
Dimensions of critical zone	+0.5 inches.

(d) Vehicle conditions. The ROPS to be tested must be attached to the vehicle structure in the same manner as it will be attached during vehicle use. A totally assembled vehicle is not

required. However, the vehicle structure and frame which support the ROPS must represent the actual vehicle installation. All normally detachable windows, panels, or nonstructural fittings shall be removed so that they do not contribute to the strength of the ROPS.

(e) Test procedure. The test procedure shall include the following, in the sequence indicated:

1. Energy absorbing capabilities of ROPS shall be verified when loaded laterally by incrementally applying a distributed load to the longitudinal outside top member of the ROPS, as shown in Figure W-1, W-2, or W-3, as applicable. The distributed load must be applied so as to result in approximately uniform deflection of the ROPS. The load increments should correspond with approximately five-tenths (0.5) inches ROPS deflection increment in the direction of the load application, measured at the ROPS top edge. Should the operator's seat be off-center, the load shall be applied on the off-center side. For each applied load increment, the total load (lb.) versus corresponding deflection (in.) shall be plotted, and the area under the load-deflection curve shall be calculated. This area is equal to the energy (in.-lb.) absorbed by the ROPS. For a typical load-deflection curve and calculation method, see Figure W-5. In Figure W-1, incremental loading shall be continued until the ROPS has absorbed the amount of energy and the minimum applied load specified under paragraph (f) of this subsection has been reached or surpassed. (See Figures for this section following the administrative regulation.)

2. To cover the possibility of the vehicle coming to rest on its top, the support capability shall be verified by applying a distributed vertical load to the top of the ROPS so as to result in approximately uniform deflection (see Figure W-1). The load magnitude is specified in paragraph (f)2a of this subsection.

3. The low temperature impact strength of the material used in the ROPS shall be verified by suitable material tests or material certification (see paragraph (f)2d of this subsection).

(f) Performance requirements.

1. General performance requirements.

a. No repairs or straightening of any member shall be carried out between each prescribed test.

b. During each test, no part of the ROPS shall enter the critical zone as detailed in SAE J397b, Society of Automotive Engineers Handbook, 1986. Deformation of the ROPS shall not allow the plane of the ground to enter this zone.

2. Specific performance requirements.

a. The energy requirement for purposes of meeting the requirements of paragraph (e)1 of this subsection is to be determined by referring to the plot of the energy versus weight of vehicle (see Figure W-6 for rubber-tired self-propelled scrapers; Figure W-7 for rubber-tired front-end loaders and rubber-tired dozers; Figure W-8 for crawler tractors and crawler-type loaders; and Figure W-9 for motor graders). For purposes of this subsection, force and weight are measured as pounds (lb.); energy (U) is measured as inch-pounds.

b. The applied load must attain at least a value which is determined by multiplying the vehicle weight by the corresponding factor shown in Figure W-10 for rubber-tired self-propelled scrapers; in Figure W-11 for rubber-tired front-end loaders and rubber-tired dozers; in Figure W-12 for crawler tractors and crawler-type loaders; and in Figure W-13 for motor graders.

c. The load magnitude for purposes of compliance with paragraph (e)2 of this subsection is equal to the vehicle weight. The test of load magnitude shall only be made after the requirements of subparagraph 2a of this paragraph are met.

d. Material used in the ROPS must have the capability of performing at zero degrees Fahrenheit, or exhibit Charpy V notch impact strength of eight (8) foot-pounds at minus twenty (20) degrees Fahrenheit. This is a standard Charpy specimen as described in American Society of



Testing and Materials A 370, Methods and Definitions for Mechanical Testing of Steel Products (available at the Central Office of the Kentucky Occupational Safety and Health Program). The purpose of this requirement is to reduce the tendency of brittle fracture associated with dynamic loading, low temperature operation, and stress raisers which cannot be entirely avoided on welded structures.

(g) Definitions. For purposes of this subsection, "vehicle weight" means the manufacturer's maximum weight of the prime mover for rubber-tired self-propelled scrapers. For other types of equipment to which this subsection applies, "vehicle weight" means the manufacturer's maximum recommended weight of the vehicle plus the heaviest attachment.

(h) Source of standard. This standard is derived from, and restates, the following Society of Automotive Engineers Recommended Practices: SAE J1349, Society of Automotive Engineers Handbook, 1986, Minimum Performance Criteria for Rollover Protective Structure for Rubber-tired, Self-propelled Scrapers; SAE J394, Society of Automotive Engineers Handbook, 1986, Minimum Performance Criteria for Rollover Protective Structure for Rubber-tired Front-end Loaders and Rubber-tired Dozers; SAE J395, Society of Automotive Engineers Handbook, 1986, Minimum Performance Criteria for Rollover Protective Structure for Crawler Tractors and Crawler-type Loaders; and SAE J396, Society of Automotive Engineers handbook, 1986, Minimum Performance Criteria for Rollover Protective Structures for Motor Graders. These recommended practices shall be resorted to in the event that questions of interpretation arise. The recommended practices appear in the 1986 SAE Handbook, which may be examined in the Central Office of the Kentucky Occupational Safety and Health Program.

(3) Protective frame (ROPS) test procedures and performance requirements for wheel-type agricultural and industrial tractors used in construction.

(a) General.

1. The purpose of this section is to set forth requirements for frames for the protection of operators of wheel-type agricultural and industrial tractors to minimize the possibility of operator injury resulting from accidental upsets during normal operation. With respect to agricultural and industrial tractors, the provisions of subsections (2) and (4) of this section for rubber-tired dozers and rubber-tired loaders may be utilized in lieu of the requirements of this section.

2. The protective frame which is the subject of this standard is a structure mounted to the tractor that extends above the operator's seat and conforms generally to Figure W-14.

3. If an overhead weather shield is attached to the protective frame, it may be in place during tests: provided, that it does not contribute to the strength of the protective frame. If such an overhead weather shield is attached, it must meet the requirements of paragraph (i) of this subsection.

4. For overhead protection requirements, see subsection (4) of this section.

5. If protective enclosures are used on wheel-type agricultural and industrial tractors, they shall meet the requirements of Society of Automotive Engineers Standard J1249, Society of Automotive Engineers Handbook, 1986, Protective Enclosures, Test Procedures, and Performance Requirements. This standard appears in the 1986 SAE Handbook and may be examined in the Central office of the Kentucky Occupational Safety and Health Program.

(b) Applicability. The requirements of this subsection apply to wheel-type agricultural tractors used in general industry work and to wheel-type industrial tractors used in general industry work. See paragraph (j) of this subsection for definitions of agricultural tractors and industrial tractors.

(c) Performance requirements.

1. Either a laboratory test or a field test is required in order to determine the performance requirements set forth in this paragraph.

2. A laboratory test may be either static or dynamic. The laboratory test must be under con-

ditions of repeatable and controlled loading in order to permit analysis of the protective frame.

~~3. A field upset test, if used, shall be conducted under reasonably controlled conditions, both rearward and sideways to verify the effectiveness of the protective frame under actual dynamic conditions.~~

~~(d) Test procedures—general.~~

~~1. The tractor used shall be the tractor with the greatest weight on which the protective frame is to be used.~~

~~2. A new protective frame and mounting connections of the same design shall be used for each test procedure.~~

~~3. Instantaneous and permanent frame deformation shall be measured and recorded for each segment of the test.~~

~~4. Dimensions relative to the seat shall be determined with the seat unloaded and adjusted to its highest and most rearward latched position provided for a seated operator.~~

~~5. If the seat is offset, the frame loading shall be on the side with the least space between the centerline of the seat and the upright.~~

~~6. The low temperature impact strength of the material used in the protective structure shall be verified by suitable material tests or material certifications in accordance with subsection (2)(f)2d of this section.~~

~~(e) Test procedure for vehicle overturn.~~

~~1. Vehicle weight. The weight of the tractor, for purposes of this subsection, includes the protective frame, all fuels, and other components required for normal use of the tractor. Ballast must be added if necessary to achieve a minimum total weight of 130 lbs. (59 kg.) per maximum power takeoff horsepower at rated engine speed. The weight of the front end must be at least thirty-three (33) lb. (15 kg.) per maximum power takeoff horsepower. In case power takeoff horsepower is unavailable, ninety-five (95) percent of net engine flywheel horsepower shall be used.~~

~~2. Agricultural tractors shall be tested at the weight set forth in subparagraph 1 of this paragraph.~~

~~3. Industrial tractors shall be tested with items of integral or mounted equipment and ballast that are sold as standard equipment or approved by the vehicle manufacturer for use with the vehicle where the protective frame is expected to provide protection for the operator with such equipment installed. The total vehicle weight and front end weight as tested shall not be less than the weights established in subparagraph 1 of this paragraph.~~

~~4. The test shall be conducted on a dry, firm soil bank as illustrated in Figure W-15. The soil in the impact area shall have an average cone index in the 0-6 inch (153 mm.) layer not less than 150 according to American Society of Agricultural Engineers Recommendation ASAE R313, Soil Cone Penetrometer (available in the Central Office of the Kentucky Occupational Safety and Health Program). The path of travel of the vehicle shall be 12°+2° to the top edge of the bank.~~

~~5. The upper edge of the bank shall be equipped with an eighteen (18) inch (457 mm.) high ramp as described in Figure W-15 to assist in tipping the vehicle.~~

~~6. The front and rear wheel tread settings, where adjustable, shall be at the position nearest to halfway between the minimum and maximum settings obtainable on the vehicle. Where only two (2) settings are obtainable, the minimum setting shall be used.~~

~~7. Vehicle overturn test—sideways and rearward.~~

~~a. The tractor shall be driven under its own power along the specified path of travel at a minimum speed of ten (10) mph (16 km./hr.) or maximum vehicle speed if under ten (10) mph (16 km./hr.) up the ramp as described in subparagraph 5 of this paragraph to induce sideways overturn.~~

~~b. Rear upset shall be induced by engine power with the tractor operating in gear to obtain 3-5 mph (4.8-8 km./hr.) at maximum governed engine r.p.m. preferably by driving forward directly up a minimum slope of two (2) vertical to one (1) horizontal. The engine clutch may be used to aid in inducing the upset.~~

~~(f) Other test procedures. When the field upset test is not used to determine ROPS performance, either the static test or the dynamic test, contained in paragraph (g) or (h) of this subsection, shall be made.~~

~~(g) Static test.~~

~~1. Test conditions.~~

~~a. The laboratory mounting base shall include that part of the tractor chassis to which the protective frame is attached including the mounting parts.~~

~~b. The protective frame shall be instrumented with the necessary equipment to obtain the required load deflection data at the location and directions specified in Figures W-16, W-17, and W-18.~~

~~c. The protective frame and mounting connections shall be instrumented with the necessary recording equipment to obtain the required load deflection data to be used in calculating FSB (see paragraph (j)3 of this subsection). The gauges shall be placed on mounting connections before the installation load is applied.~~

~~2. Test procedure.~~

~~a. The side load application shall be at the upper extremity of the frame upright at a ninety (90) degree angle to the centerline of the vehicle. This side load "L" shall be applied according to Figure W-16. "L" and "D" shall be recorded simultaneously. The test shall be stopped when:~~

~~(i) The strain energy absorbed by the frame is equal to the required input energy ( $E_{is}$ ); or~~

~~(ii) Deflection of the frame exceeds the allowable deflection; or~~

~~(iii) The frame load limit occurs before the allowable deflection is reached in the side load.~~

~~b. The L-D diagram, as shown by means of a typical example in Figure W-19, shall be constructed, using the data obtained in accordance with clause a of this subparagraph.~~

~~c. The modified  $L_m$ - $D_m$  diagram shall be constructed according to clause (ii) of this subparagraph and according to figure W-20. the strain energy absorbed by the frame ( $E_u$ ) shall then be determined.~~

~~d.  $E_{is}$ , FER, and FSB shall be calculated.~~

~~e. The test procedure shall be repeated on the same frame utilizing L (rear input; see Figure W-18) and  $E_{ir}$ . Rear load application shall be uniformly distributed along a maximum projected dimension of twenty-seven (27) inches (686 mm.) and a maximum area of 160 square inches (1,032 sq. cm.) normal to the direction of load application. The load shall be applied to the upper extremity of the frame at the point which is midway between the centerline of the seat and the inside of the frame upright.~~

~~(h) Dynamic test.~~

~~1. Test conditions.~~

~~a. The protective frame and tractor shall meet the requirements of paragraph (e)2 or 3 of this subsection, as appropriate.~~

~~b. The dynamic loading shall be produced by use of a 4,410 lb. (2,000 kg.) weight acting as a pendulum. The impact face of the weight shall be twenty-seven (27) plus, or minus one (1) inch by twenty-seven (27) plus or minus one (1) inch (686 + or - 25 mm.) and shall be constructed so that its center of gravity is within one (1) inch (25.4 mm.) of its geometric center. The weight shall be suspended from a pivot point 18-22 feet (5.5-6.7 m.) above the point of impact on the frame and shall be conveniently and safely adjustable for height. (See Figure W-21).~~

~~c. For each phase of testing, the tractor shall be restrained from moving when the dynamic~~

load is applied. The restraining members shall be of 0.5-0.63 inch (12.5-16 mm.) steel cable and points of attaching restraining members shall be located an appropriate distance behind the rear axle and in front of the front axle to provide a 15°-30° angle between a restraining cable and the horizontal. The restraining member shall either be in the plane in which the center gravity of the pendulum will swing or more than one (1) restraining cable shall give a resultant force in this plane. (See Figure W-22).

d. The wheel tread setting shall comply with the requirements of paragraph (c)6 of this subsection. The tires shall have no liquid ballast and shall be inflated to the maximum operating pressure recommended by the tire manufacturer. With specified tire inflation, the restraining cables shall be tightened to provide tire deflection of 6-8 percent of nominal tire section width. After the vehicle is properly restrained, a wooden beam 6 x 6 in. (15 x 15 cm.) shall be driven tightly against the appropriate wheels and clamped. For the test to the side, an additional wooden beam shall be placed as a prop against the wheel nearest the operator's station and shall be secured to the floor so that it is held tightly against the wheel rim during impact. The length of this beam shall be chosen so that when it is positioned against the wheel rim, it is at an angle of 25°-40° to the horizontal. It shall have a length 20-25 times its depth and a width two (2) to three (3) times its depth. (See Figures W-22 and W-23.)

e. Means shall be provided indicating the maximum instantaneous deflection along the line of impact. A simple friction device is illustrated in Figure W-23.

f. No repair or adjustments may be carried out during the test.

g. If any cables, props, or blocking shift or break during the test, the test shall be repeated.

## 2. Test procedure.

a. General. The frame shall be evaluated by imposing dynamic loading to rear followed by a load to the side on the same frame. The pendulum dropped from the height (see definition "H" in paragraph (j)3 of this subsection) imposes the dynamic load. The position of the pendulum shall be so selected that the initial point of impact on the frame shall be in line with the arc of travel of the center of gravity of the pendulum. A quick release mechanism should be used but, if used, shall not influence the attitude of the block.

b. Impact at rear. The tractor shall be properly restrained according to subparagraphs 1c and d of this paragraph. The tractor shall be positioned with respect to the pivot point of the pendulum such that the pendulum is twenty (20) degrees from the vertical prior to impact, as shown in Figure W-22. The impact shall be applied to the upper extremity of the frame at the point which is midway between the centerline of the seat and the inside of the frame upright of a new frame.

c. Impact at side. The block and restraining shall conform to subparagraphs 1c and d of this paragraph. The point of impact shall be that structural member of the protective frame likely to hit the ground first in a sideways accidental upset. The side impact shall be applied to the side opposite that used for rear impact.

(i) Performance requirements.

### 1. General.

a. The frame, overhead weather shield, fenders, or other parts in the operator area may be deformed but shall not shatter or leave sharp edges exposed to the operator, or violate dimensions as shown in Figures W-16 and W-17 as follows:

D = 2 in. (51 mm.) inside of frame upright to vertical centerline of seat.

E = 30 in. (762 mm.).

F = Not less than 0 in. and not more than 12 in. (305 mm.), measured at centerline front of seat backrest to crossbar along the

~~line of load application as shown in Figure W-17.~~

~~G = 24 in. (610 mm.).~~

~~b. The material and design combination used in the protective structure must be such that the structure can meet all prescribed performance tests at zero degrees Fahrenheit in accordance with subsection (2)(f)2d.~~

~~2. Vehicle overturn performance requirements. The requirements of this paragraph must be met in both side and rear overturns.~~

~~3. Static test performance requirements. Design factors shall be incorporated in each design to withstand an overturn test as prescribed in this paragraph. The structural requirements will be generally met if FER is greater than one (1) and FSB is greater than K-1 in both side and rear loadings.~~

~~4. Dynamic test performance requirements. Design factors shall be incorporated in each design to withstand the overturn test prescribed in this paragraph. The structural requirements will be generally met if the dimensions in this paragraph are adhered to in both side and rear loads.~~

~~(j) Definitions applicable to this section.~~

~~1. SAE J1194, Society of Automotive Engineers Handbook, 1986, Operator Protection for Wheel-type Agricultural and Industrial Tractors (1983) defines "agricultural tractor" as a "wheel-type vehicle of more than 20 engine horsepower designed to furnish the power to pull, carry, propel, or drive implements that are designed for agricultural usage." Since this subsection applies only to general industry work, the following definition of "agricultural tractor" is adopted for purposes of this administrative regulation: "agricultural tractor" means a wheel-type vehicle of more than twenty (20) engine horsepower, used in general industry work, which is designed to furnish the power to pull, propel, or drive implements.~~

~~2. "Industrial tractor" means that class of wheeled-type tractor of more than twenty (20) engine horsepower (other than rubber-tired loaders and dozers described in subsection (2) of this section) used in operations such as landscaping, loading, digging, grounds keeping, and highway maintenance.~~

~~3. The following symbols, terms, and explanations apply to this section:~~

~~E<sub>is</sub> = Energy input to be absorbed during side loading.~~

~~E'<sub>is</sub> = 723 + 0.4 W ft.-lb. (E'<sub>is</sub> = 100 + 0.12W', m.-kg.).~~

~~E<sub>ir</sub> = Energy input to be absorbed during rear loading.~~

~~E'<sub>ir</sub> = 0.47 W ft.-lb. (E'<sub>ir</sub> = 0.14 W', m.-kg.).~~

~~W = Tractor weight as prescribed in subsection (3)(e)1 and (e)3, in lb. (W', kg.). L = Static load, lb. (kg.).~~

~~D = Deflection under L, in. (mm.).~~

~~L-D = Static load-deflection diagram.~~

~~L<sub>m</sub>D<sub>m</sub> = Modified static load-deflection diagram (Figure W-20). To account for increase in strength due to increase in strain rate, raise L in plastic range to L x K.~~

~~K = Increase in yield strength induced by higher rate of loading (1.3 for hot rolled low carbon steel 1010-1030). Low carbon is pref-~~

erable; however, if higher carbon or other material is used, K must be determined in the laboratory. Refer to Charles H. Norris, et al., Structural Design for Dynamic Loads (1959), p. 3.

$L_{max}$  = Maximum observed static load.

Load = Point on L-D curve where observed static load is Limit  $0.8 L_{max}$  (refer to Figure W-19).

$E_u$  = Strain energy absorbed by the frame, ft.-lb. (m.-kg.) area under  $L_m D_m$  curve.

FER = Factor of energy ratio,  $FER = E_u/E_{is}$  also =  $E_u/E_{ir}$

$P_b$  = Maximum observed force in mounting connection under static load, L, lb. (kg.).

FSB = Design margin for mounting connection  $FSB = (P_u/P_b)-1$ .

H = Vertical height of lift of 4.410 lb. (2,000 kg.) weight, in. (H', mm.). The weight shall be pulled back so that the height of its center of gravity above the point of impact is defined as follows:  $H = 4.92 + 0.00190 W$  or  $(H' = 125 + 0.107 W')$  (Figure W-24).

~~(k) Source of standard. The standard in this section is derived from, and restates, Society of Automotive Engineers Standard J1194, Society of Automotive Engineers Handbook, 1986, Protective Frame Test Procedures and Performance Requirements. This standard shall be resorted to in the event that questions of interpretation arise. The standard appears in the 1986 SAE Handbook, which may be examined in the Central Office of the Kentucky Occupational Safety and Health Program.~~

~~(4) Overhead protection for operators of agricultural and industrial tractors.~~

~~(a) General.~~

~~1. Purpose. When overhead protection is provided on wheel-type agricultural and industrial tractors, the overhead protection shall be designed and installed according to the requirements contained in this subsection. The provisions of subsection (2) of this section for rubber-tired dozers and rubber-tired loaders may be used in lieu of the standards contained in this subsection. The purpose of the standard is to minimize the possibility of operator injury resulting from overhead hazards such as flying and falling objects, and at the same time to minimize the possibility of operator injury from the cover itself in the event of accidental upset.~~

~~2. Applicability. This standard applies to wheel-type agricultural tractors used in general industry work and to wheel-type industrial tractors used in general industry work.~~

~~(b) Overhead protection. When overhead protection is installed on wheel-type agricultural or industrial tractors used in general industry work, it shall meet the requirements of this paragraph. The overhead protection may be constructed of a solid material. If grid or mesh is used, the largest permissible opening shall be such that the maximum circle which can be inscribed between the elements of the grid or mesh is 1.5 in. (38 mm.) in diameter. The overhead protection shall not be installed in such a way as to become a hazard in the case of upset.~~

~~(c) Test procedures - general.~~

~~1. The requirements of subsection (3)(d), (e), and (f) of this section shall be met.~~

~~2. Static and dynamic rear load application shall be uniformly distributed along a maximum~~

projected dimension of 27 in. (686 mm.) and a maximum area of 160 inch<sup>2</sup> (1,032 cm.<sup>2</sup>) normal to the direction of load application. The load shall be applied to the upper extremity of the frame at the point which is midway between the centerline of the seat and the inside of the frame upright.

3. The static and dynamic side load application shall be uniformly distributed along a maximum projected dimension of 27 in. (686 mm.) and a maximum area of 160 inch<sup>2</sup> (1,032 cm.<sup>2</sup>) normal to the direction of load application. The direction of load application is the same as in subsection (3)(g) and (h) of this section. To simulate the characteristics of the structure during an upset, the center of load application may be located from a point 24 in. (610 mm.) (K) forward to 12 in. (305 mm.) (L) rearward of the front of the seat backrest to best utilize the structural strength. See Figure W-25.

(d) Drop test procedures.

1. The same frame shall be subjected to the drop test following either the static or dynamic test.

2. A solid steel sphere or material of equivalent spherical dimension weighing 100 lb. (45.4 kg.) shall be dropped once from a height 10 ft. (3,048 mm.) above the overhead cover.

3. The point of impact shall be on the overhead cover at a point within the zone of protection as shown in Figure W-26, which is furthest removed from major structural members.

(e) Crush test procedures.

1. The same frame shall be subjected to the crush test following the drop test and static or dynamic test.

2. The test load shall be applied as shown in Figure W-27 with the seat positioned as specified in subsection (3)(d)4 of this section. Loading cylinders shall be pivotally mounted at both ends. Loads applied by each cylinder shall be equal within two (2) percent, and the sum of the loads of the two (2) cylinders shall be two (2) times the tractor weight as set forth in subsection (3)(e)1 of this section. The maximum width of the beam illustrated in Figure W-27 shall be 6 in. (152 mm.).

(f) Performance requirements.

1. General. The performance requirements set forth in subsection (3)(i)2, 3, and 4 of this section shall be met.

2. Drop test performance requirements.

a. Instantaneous deformation due to impact of the sphere shall not enter the protected zone as illustrated in Figure W-25, W-26, and W-28.

b. In addition to the dimensions set forth in subsection (3)(i)1a of this section, the following dimensions apply to Figure W-28:

H = 17.5 in. (444 mm.).

J = 2 in. (50.8 mm.) measured from the outer periphery of the steering wheel.

3. Crush test performance requirements. The protected zone as described in Figure W-28 must not be violated.

(g) Source of standard. This standard is derived from, and restates, the portions of Society of Automotive Engineers Standard J167, Society of Automotive Engineers Handbook, 1986, which pertain to overhead protection requirements. The full title of the SAE standard is: Protective Frame with Overhead Protection test Procedures and Performance Requirements. The SAE standard shall be resorted to in the event that questions of interpretation arise. The SAE standard appears in the 1986 SAE Handbook, which may be examined in the Central Office of the Kentucky Occupational Safety and Health Program.

Section 6.] Fire Apparatus and Fire Department Facilities. (1) Scope. This section shall ap-

ply to industrial fire departments and private, public or contractual type fire departments. This section shall not apply to volunteer fire departments.

(2) Persons riding on fire apparatus. ~~A [Beginning September 1, 1991, a]~~ person riding on fire apparatus shall be secured to the vehicle by seat belts or safety harnesses when the vehicle is in motion.

(3) Inspection, maintenance, and repair of vehicles. ~~[Beginning January 1, 1992:]~~

(a) All fire department vehicles shall be inspected at least weekly and within twenty-four (24) hours after any use or repair to identify and correct unsafe conditions.

(b) A fire department vehicle found to be unsafe shall be placed out of service until repaired.

(c) After being repaired, the vehicle shall be inspected prior to being placed back in service.

(d) ~~[(e)]~~ The inspection shall include:

1. Tires, brakes, warning lights and devices, headlights and clearance lights, windshield wipers and mirrors;

2. Starting the apparatus, and verification of the operation of pumps and other equipment; and

3. Inspection of the safety equipment carried on fire department vehicles.

(e) ~~[(d)]~~ A fire department shall maintain inspection, maintenance, repair, and service records for all vehicles and equipment used for emergency operations.

(4) Facility safety. ~~[Beginning July 1, 1993:]~~

(a) Sleeping areas in fire stations shall:

1. Be separated from vehicle storage areas by at least one (1) hour fire resistive assemblies; or

2. Have operable fire suppression or operable smoke detection systems.

(b) A fire station shall have a system capable of ventilating. [

~~(5) Effective dates.~~

~~(a) Subsection (2) of this section shall become effective September 1, 1991.~~

~~(b) Subsection (3) of this section shall become effective January 1, 1992.~~

~~(c) Subsection (4) of this section shall become effective July 1, 1993.~~

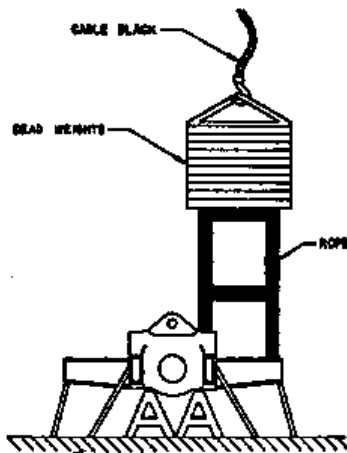

Figure W-1-Vertical loading setup for all types of equipment described in Subsection (2)(a).

Incremental loading shall be continued until the ROPS has absorbed the amount of energy and the minimum applied load specified under paragraph (f) of this Subsection has been reached or surpassed.



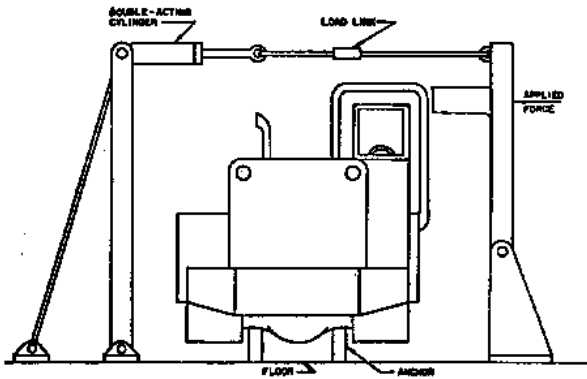

FIGURE W-2—Test setup for rubber-tired self-propelled scrapers.

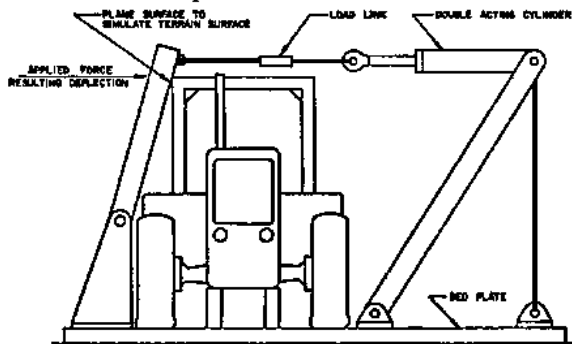

FIGURE W-3—Test setup for rubber-tired front-end loaders, rubber-tired dozers, and motor graders.

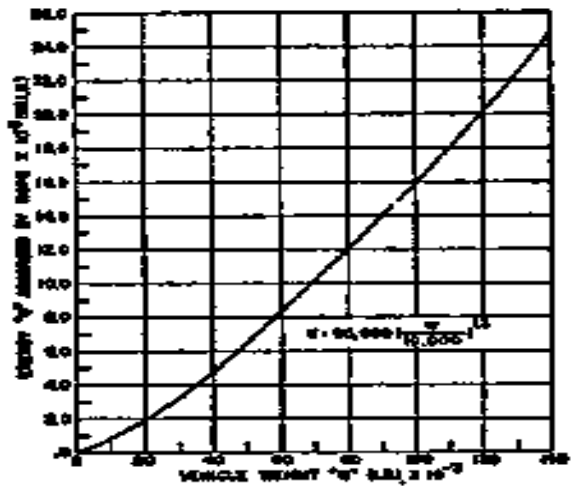

FIGURE W-3—Energy absorbed versus vehicle weight.

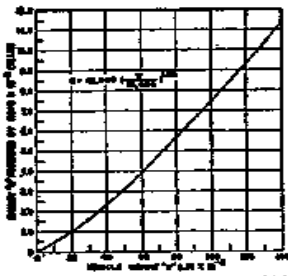

FIGURE W-7—Energy absorbed versus vehicle weight.

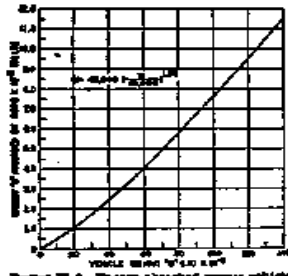

FIGURE W-8—Energy absorbed versus vehicle weight.

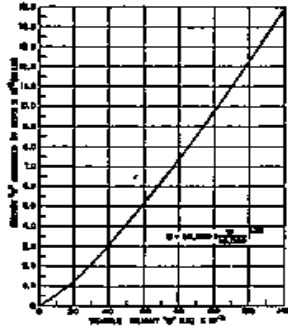

FIGURE W-9—Energy absorbed versus vehicle weight.

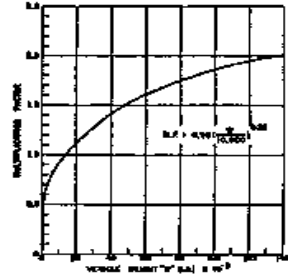

FIGURE W-10—Minimum horizontal load factor for self-propelled scrapers.

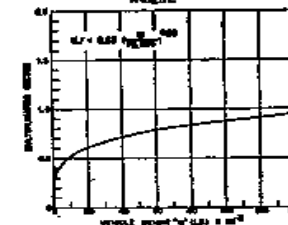

FIGURE W-11—Minimum horizontal load factor for rubber-tired loaders and dozers.

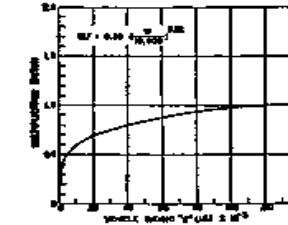

FIGURE W-12—Minimum horizontal load factor for crawler tractors and wheel-type loaders.



FIGURE W-13—Minimum horizontal load factor for motor graders.

17

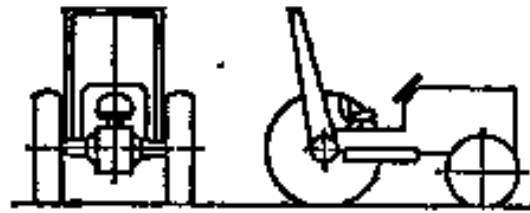
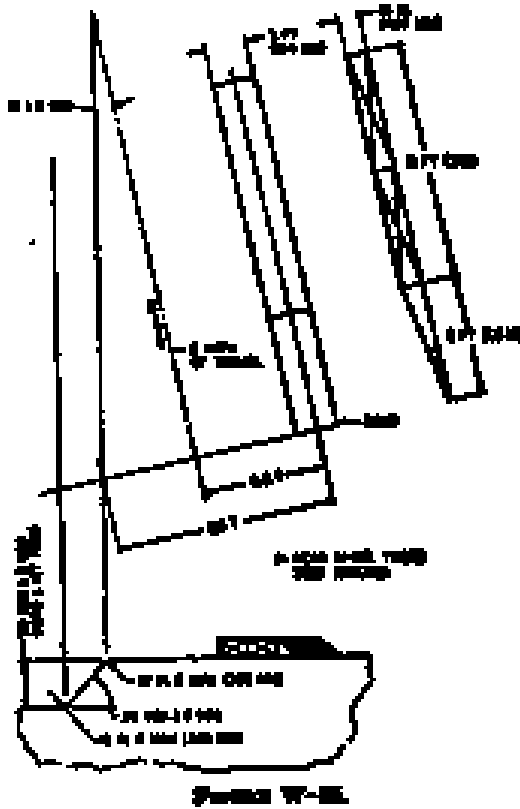

FIGURE W-14—Typical frame configuration.



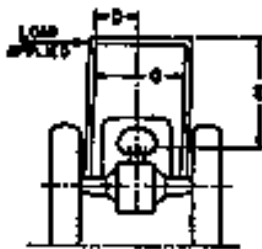

FIGURE W-16—Side load application.

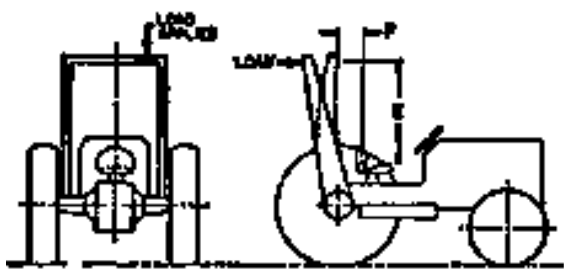
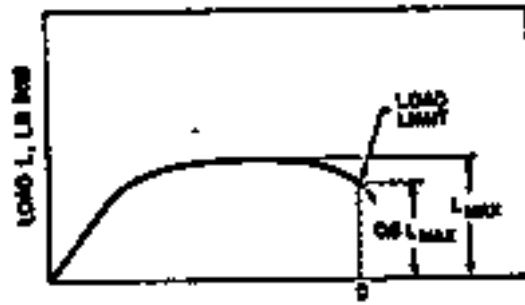

FIGURE W-17—Rear load application.

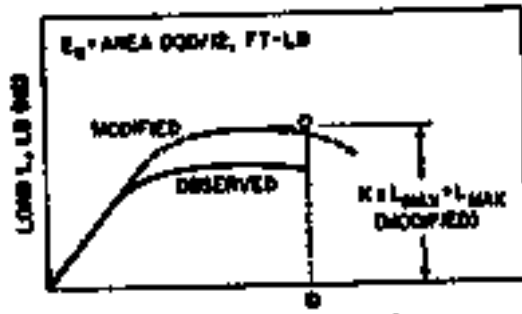

FIGURE W-18—Method of measuring instantaneous deflection.



DEFLECTION D, IN (MM)

FIGURE W-19—Typical L-D diagram.



DEFLECTION D, IN (MM)

FIGURE W-20—Typical modified L-D<sub>m</sub> diagram.

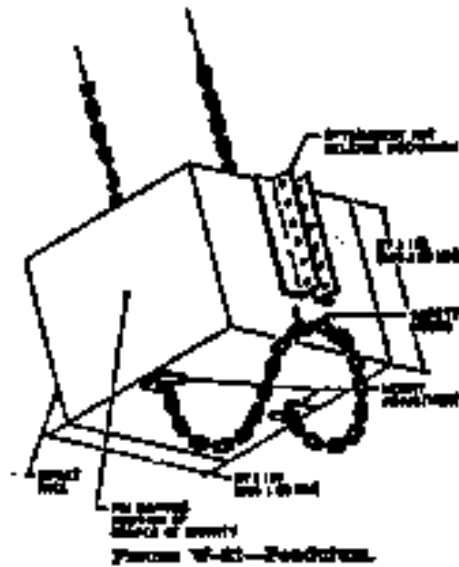

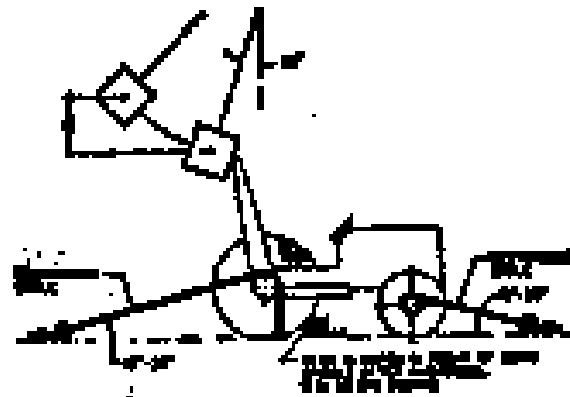

Figure W-22—Method of impact from rear.

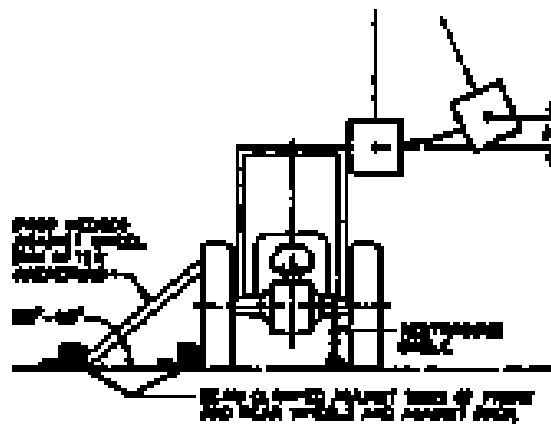
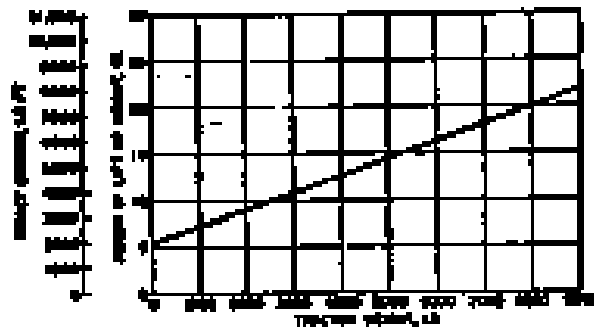
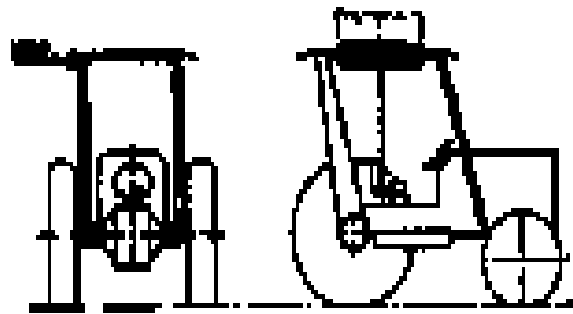

Figure W-23—Method of impact from side.



Equation of Figure W-24  
 $h = 4.10 \times \frac{E}{1000}$   
 $E = \text{impact energy, ft-lb}$   
 $h = \text{lift height, ft}$

Figure W-24—Impact energy and corresponding lift height of 4.10 lb. (2,000 kg.) weight.



**FIGURE W-25—Locations for side load.**

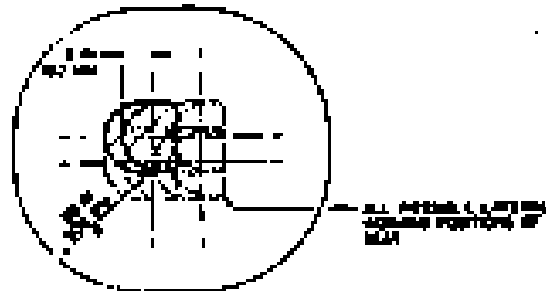

**FIGURE W-26—Some of protection for drop test.**

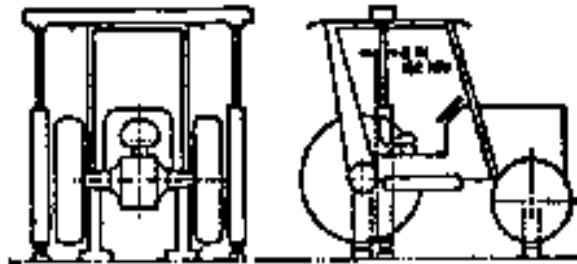

**FIGURE W-27—Method of load application for crush test.**

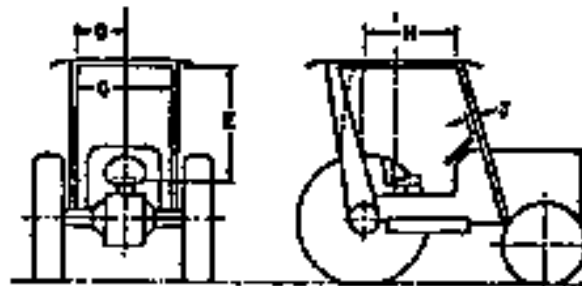

**FIGURE W-28—Protected zone during crush and drop tests.**

LARRY ROBERTS, Secretary of Labor  
 APPROVED BY AGENCY: April 26, 2021  
 FILED WITH LRC: April 27, 2021 at 9:39 a.m.

**PUBLIC HEARING AND PUBLIC COMMENT PERIOD:** A public hearing on this administrative regulation shall be held on July 21, 2021 at 10:00 am (ET). The meeting will be conducted by live videoconference (ZOOM) pursuant to Senate Bill 150, Section 1, subparagraph (8) b (2020) and the continuing state of emergency. Public access to the meeting will be available at <https://us02web.zoom.us/j/86731399141?pwd=Q2VOcDQ3ZkVBaUtoNERCMDNIKzZJZz09>, password 446261; or by telephone at (713) 353-0212, (888) 822-7517 toll free, conference code 194378. Individuals interested in being heard at this hearing shall notify this agency in writing five (5) working days prior to the hearing of their intent to attend. If no notification of intent to attend the hearing is received by that date, the hearing may be canceled. This hearing is open to the public. Any person who wishes to be heard will be given an opportunity to comment on the proposed administrative regulation. A transcript of the public hearing will not be made unless a written request for a transcript is made. If you do not wish to attend the public hearing, you may submit written comments on the proposed administrative regulation. Written comments shall be accepted through July 31, 2021. Send written notification of intent to be heard at the public hearing or written comments on the proposed administrative regulation to the contact person.

**CONTACT PERSON:** Robin Maples, OSH Standards Specialist, Labor Cabinet, Mayo-Underwood Building, 500 Mero Street, 3rd Floor, Frankfort, Kentucky 40601, phone (502) 564-4107, fax (502) 564-4769, email [Robin.Maples@ky.gov](mailto:Robin.Maples@ky.gov).

## REGULATORY IMPACT ANALYSIS AND TIERING STATEMENT

Contact person: Robin Maples

(1) Provide a brief summary of:

(a) What this administrative regulation does: Section 1 of this administrative regulation, effective since August 3, 1977, defines terms. Section 2 maintains the requirements regarding automotive-type batteries. Section 3 maintains the requirements for off highway motor vehicles and equipment. Section 4 maintains the requirements for fire apparatus and fire department facilities. Amendment to the aforementioned sections are primarily technical and intended to maintain consistency with other regulations. Amendment to this administrative regulation also strikes several requirements; specifically, safety and testing of supply lines in excess of 600 volts, safety belts, lanyards, and lifelines, as well as rollover protective structures and overhead protection. Other occupational safety and health (OSH) standards address the requirements that are removed. This amendment also updates this administrative regulation to meet KRS Chapter 13A considerations and was reviewed in accordance with House Bill (HB) 50 from the Regular Session of the 2017 General Assembly.

(b) The necessity of this administrative regulation: This administrative regulation maintains employer and employee OSH protections. The regulation promotes employer and employee OSH throughout Kentucky.

(c) How this administrative regulation conforms to the content of the authorizing statutes: KRS 338.051(3) requires the Kentucky OSH Standards Board to promulgate OSH administrative regulations. This regulation complies and conforms with the authorizing statutes.

(d) How this administrative regulation currently assists or will assist in the effective administration of the statutes: This administrative regulation, effective since August 3, 1977, promotes worker safety and health throughout Kentucky by maintaining employers and employees OSH protections.

(2) If this is an amendment to an existing administrative regulation, provide a brief summary of:

(a) How the amendment will change this existing administrative regulation: Section 1 of this



administrative regulation, effective since August 3, 1977, defines terms. Section 2 maintains the requirements regarding automotive-type batteries. Section 3 maintains the requirements for off highway motor vehicles and equipment. Section 4 maintains the requirements for fire apparatus and fire department facilities. Amendment to the aforementioned sections are primarily technical and intended to maintain consistency with other regulations. Amendment to this administrative regulation also strikes requirements addressing safety and testing of supply lines in excess of 600 volts, safety belts, lanyards, and lifelines, as well as rollover protective structures and overhead protection. Other OSH standards address the requirements that are removed. This amendment also updates this administrative regulation to meet KRS Chapter 13A considerations and was reviewed in accordance with HB 50 from the Regular Session of the 2017 General Assembly.

(b) The necessity of the amendment to this administrative regulation: This administrative regulation, effective since August 3, 1977, promotes worker safety and health throughout Kentucky.

(c) How the amendment conforms to the content of the authorizing statutes: This administrative regulation complies and conforms with the authorizing statutes of KRS 338.051 and 338.061. KRS 338.051(3) and 338.061 authorize the Kentucky OSH Standards Board to promulgate OSH administrative regulations.

(d) How the amendment will assist in the effective administration of the statutes: This amendment provides all a clear understanding of the requirements. It promotes employer and employee occupational safety and health throughout Kentucky.

(3) List the type and number of individuals, businesses, organizations, or state and local governments affected by this administrative regulation: This administrative regulation affects all employers in the Commonwealth in general industry covered by KRS Chapter 338.

(4) Provide an analysis of how the entities identified in question (3) will be impacted by either the implementation of this administrative regulation, if new, or by the change, if it is an amendment, including: (a) List the actions that each of the regulated entities identified in question (3) will have to take to comply with this administrative regulation or amendment: No additional compliance duties are imposed and no immediate action is required.

(b) In complying with this administrative regulation or amendment, how much will it cost each of the entities identified in question (3): There is no additional cost to the OSH Program to implement this administrative regulation.

(c) As a result of compliance, what benefits will accrue to the entities identified in question (3):  
Improved employee protection will result from clarification of the regulation.

(5) Provide an estimate of how much it will cost to implement this administrative regulation: (a) Initially: There is no cost to the OSH Program to implement this administrative regulation.

(b) On a continuing basis: There is no continuing cost to the OSH Program to implement this administrative regulation.

(6) What is the source of the funding to be used for the implementation and enforcement of this administrative regulation: Current state and federal funding.

(7) Provide an assessment of whether an increase in fees or funding will be necessary to implement this administrative regulation, if new or by the change if it is an amendment: There is neither an increase in fees nor an increase in funding necessary to implement this amendment.

(8) State whether or not this administrative regulation establishes any fees or directly or indirectly increases any fees: This administrative regulation neither establishes any fees nor directly or indirectly increases any fees.

(9) TIERING: Is tiering applied? Tiering is not applied. All employers covered by KRS Chap-

ter 338 are treated equally.

## FEDERAL MANDATE ANALYSIS COMPARISON

1. Federal statute or regulation constituting the federal mandate. Not applicable.
2. State compliance standards. This regulation provides OSH protections to employees and employers; OSHA does not have an equivalent standard.
3. Minimum or uniform standards contained in the federal mandate. Not applicable.
4. Will this administrative regulation impose stricter requirements, or additional or different responsibilities or requirements, than those required by the federal mandate? Yes.
5. Justification for the imposition of the stricter standard, or additional or different responsibilities or requirements: There is no equivalent federal standard. This regulation, effective since August 3, 1977, maintains employer and employee OSH protections.

## FISCAL NOTE ON STATE OR LOCAL GOVERNMENT

1. What units, parts or divisions of state or local government (including cities, counties, fire departments, or school districts) will be impacted by this administrative regulation? This administrative regulation affects any unit, part, or division of state or local government covered by KRS Chapter 338 in general industry.

2. Identify each state or federal statute or federal regulation that requires or authorizes the action taken by the administrative regulation. KRS 338.051, KRS 338.061

3. Estimate the effect of this administrative regulation on the expenditures and revenues of a state or local government agency (including cities, counties, fire departments, or school districts) for the first full year the administrative regulation is to be in effect. None.

(a) How much revenue will this administrative regulation generate for the state or local government (including cities, counties, fire departments, or school districts) for the first year? None.

(b) How much revenue will this administrative regulation generate for the state or local government (including cities, counties, fire departments, or school districts) for subsequent years? None.

(c) How much will it cost to administer this program for the first year? There are no costs associated with this amendment.

(d) How much will it cost to administer this program for subsequent years? There are no costs associated with this amendment.

Note: If specific dollar estimates cannot be determined, provide a brief narrative to explain the fiscal impact of the administrative regulation.

Revenues (+/-): Unknown.

Expenditures (+/-): Unknown.

Other explanation: This amendment does not impose any additional requirements or expenditures.